

# Oval gear flow meter // VO, Sensor



Version  
with thread



Version  
with flange



## Highlights

- high measurement accuracy and repeatability
- low pressure drop
- applicable for fluids such as lubrication oils, mineral oils, hydraulic oils, fuels and liquified gases
- insensitive to vibrations, pressure changes and viscosity changes

## Technical data

Type	VO015	VO06	VO1	VO2	VO5	VO10	VO50	VO115
<b>Measuring range [l/min]</b>								
→ Oval gears stainless steel	0.03...1	0.2...5	0.4...10	1...30	2...50	4...100	15...300	35...660
→ Oval gears PEEK	0.03...1	0.2...7	0.4...14	1...30	2...60	3...120	not available	
<b>Process connection</b>								
→ Thread	G $\frac{1}{4}$	G $\frac{1}{2}$	G $\frac{1}{2}$	G $\frac{3}{4}$	G 1	G 1	G 2	G 2
→ Flange (according to DIN EN 1092-1)				DN 15		DN 25	DN 50	DN 50
<b>Nominal puls rate [1/l]</b>	3100	333	166	100	40	20	4	1.7

# Technical data

Technical data			
Type	VO...VA	VO...VP	VO...AP
	Housing stainless steel Oval gears stainless steel	Housing stainless steel Oval gears PEEK	Housing aluminium Oval gears PEEK
<b>Accuracy*</b>	±0.5 % of reading		
<b>Repeatability*</b>	< 0.05 %		
<b>Pressure rating</b> → Version with thread → Version with flange	PN 68 (PN 25 with FEP O-ring) PN 40 (PN 25 with FEP O-ring)		PN 40 (PN 25 with FEP O-ring) PN 40 (PN 25 with FEP O-ring)
<b>Temperature range</b>			
<b>Standard</b>	-20...80 °C	-20...70 °C	-10...80 °C
<b>High temperature sensor</b>	-25...130 °C	not available	
<b>Materials</b>			
<b>Housing</b>	Stainless steel	Stainless steel	Aluminium
<b>Oval gears</b>	Stainless steel	PEEK	PEEK
<b>O-ring</b>	FKM (standard) or EPDM (option) or FEP (option)	FKM (standard) or EPDM (option) or FEP (option)	FKM (standard) or EPDM (option) or FEP (option)
<b>Medium</b>			
<b>Allowable Viscosity</b>	0.3...350 mPa s	0.3...150 mPa s	
<b>Max. particle size</b>	25...100 µm		
<b>Electrical data</b>			
<b>Supply voltage</b> → Standard → High temperature sensor	10...30 VDC 18...30 VDC	10...30 VDC	10...30 VDC
<b>Electrical connection</b> → Standard → High temperature sensor	M12 x 1 connector 2 m silicone cable, 3 x 0.14 mm		
<b>Signal output</b>			
<b>Standard</b>	NPN, PNP	NPN, PNP	NPN, PNP
<b>High temperature sensor</b>	PNP	not available	
<b>Degree of protection EN 60529</b>	IP67		

- \* Test conditions:  
 → Viscosity >3 mPa s  
 → Media temperature 20 °C

# Oval gear flow meter // VO, display

## Highlights

- Actual flow rate indication
- Up to two VO sensors can be connected; configurable for differential measurement (Display 2 and 3)
- Total flow indication, password protected counter
- Optionally available for wall mounting with bracket (for media temperatures up to 70 °C)

Electrical data			
Type	Display 1	Display 2	Display 3
Display	8 digit		
Power supply	Battery	Battery	10...30 VDC
Power consumption			100 mA, 28 V
Signal outputs	without	Pulse output Open collector	Pulse output Open collector Analogue output 4...20 mA / 2-wire
Electrical connection		Terminal block in the wiring compartment	
Cable length*		2000 mm	
Degree of protection EN 60529	IP65		
Temperature range			
Medium temperature			
→ standard	-20...80 °C		
→ high temperature	-20...125 °C		
Ambient temperature	-20...70 °C		
Storage temperature	10...55 °C		
Type			
Local (meter mounted)	✓	✓	✓
Remote (wall mounting)		✓	✓

\* remote type / wall mounting

# Typical pressure drop

Typical pressure drop V0015

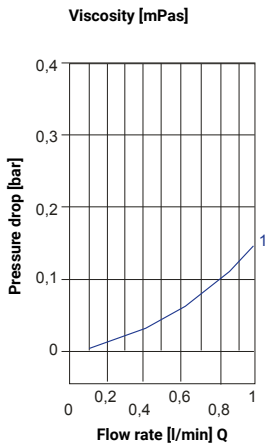

Typical pressure drop V006

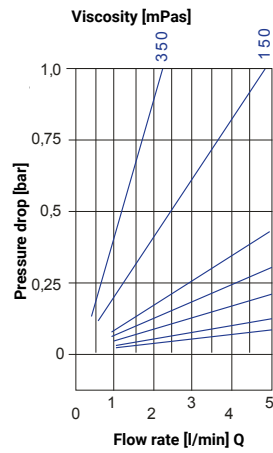

Typical pressure drop V01

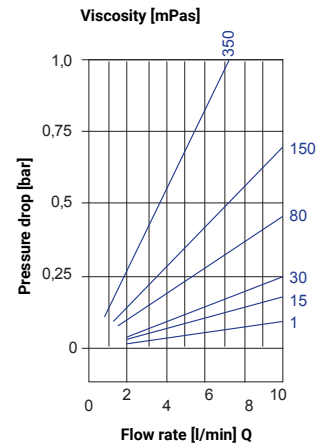

Typical pressure drop V02

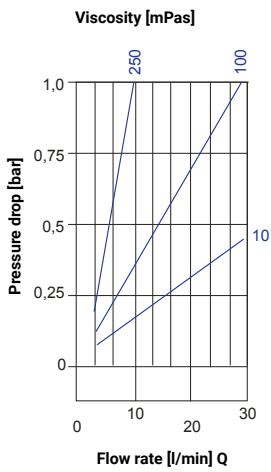

Typical pressure drop V05

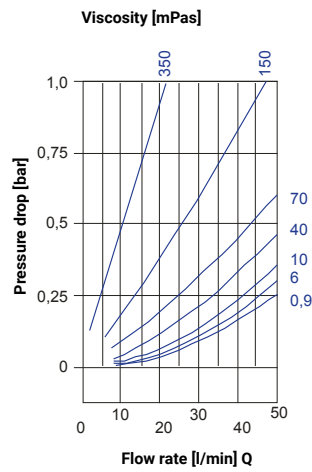

Typical pressure drop V010

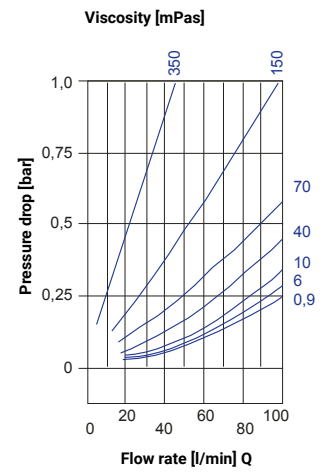

Typical pressure drop V050

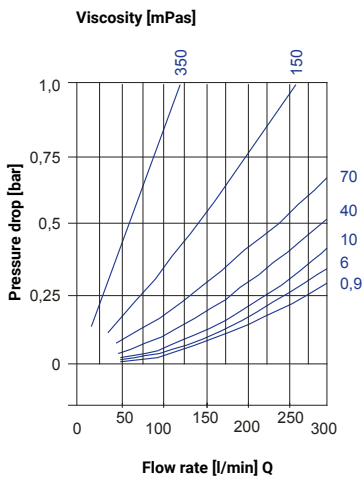

Typical pressure drop V0115

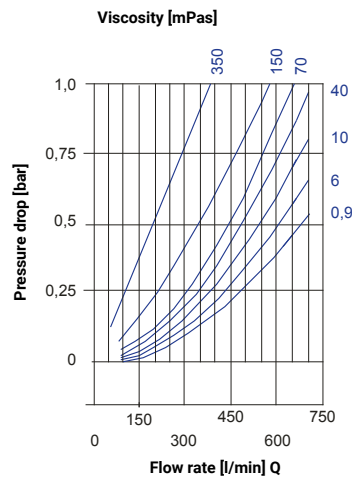

# Technical drawings // Dimensions

## Process connection threaded

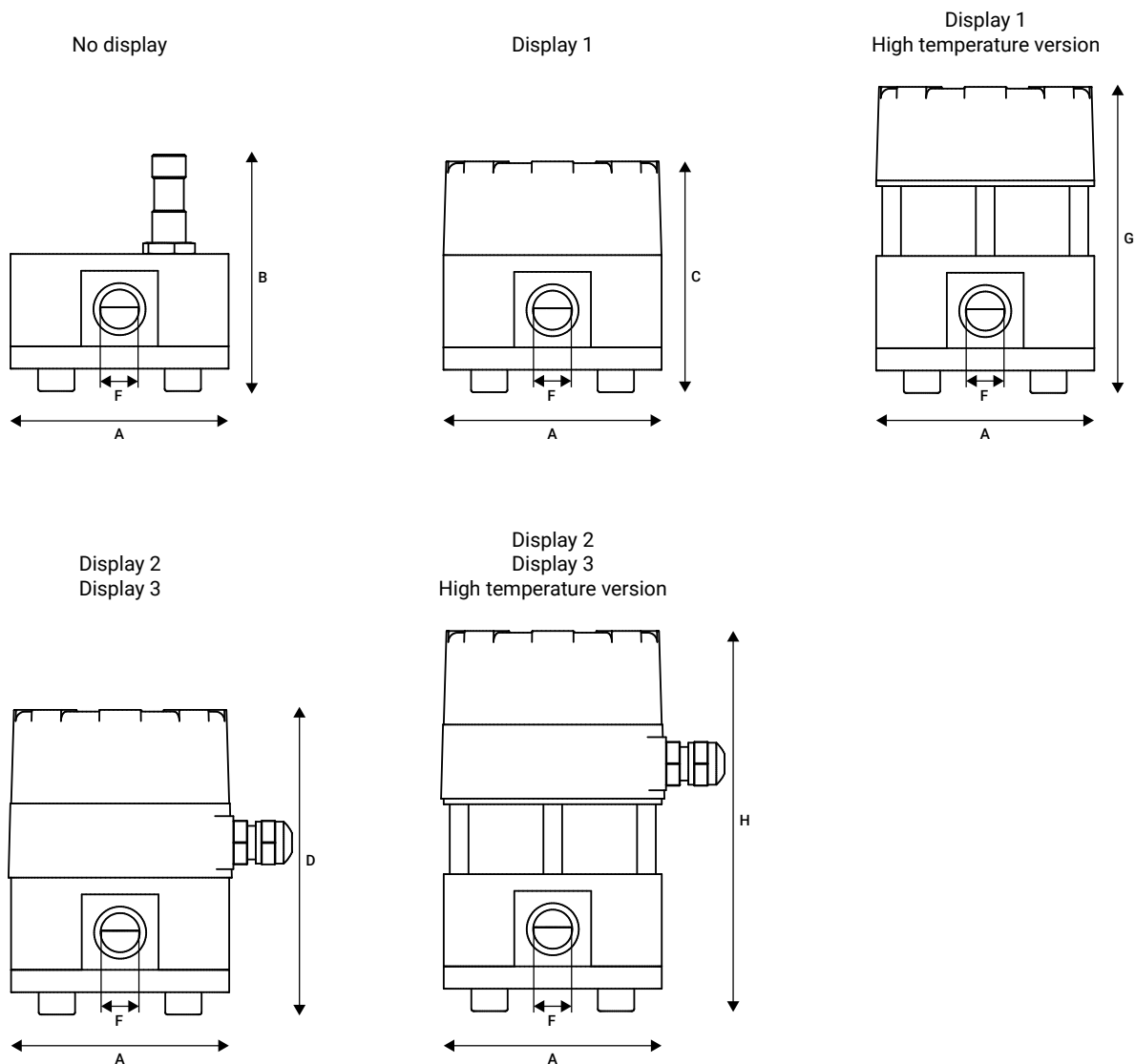

Dimensions [mm]								
Size	V0015	V006	V01	V02	V05	V010	V050	V0115
<b>A</b>	78	78	78	99	112	112	220	260
<b>C</b>	70	75	85	93	98	125	187	245
<b>B<sub>max</sub> * D</b>	96	101	111	120	125	152	213	271
<b>G</b>	97	102	112	120	125	152	214	272
<b>H</b>	123	128	138	147	152	179	240	298
<b>Installation</b>	73	73	73	90	102	102	184	196
<b>F / Process connection</b>	G $\frac{1}{4}$	G $\frac{1}{2}$	G $\frac{1}{2}$	G $\frac{3}{4}$	G 1	G 1	G 2	G 2

\* Depends on sensor

# Technical drawings // Dimensions

Process connection flanged according to DIN EN 1092-1

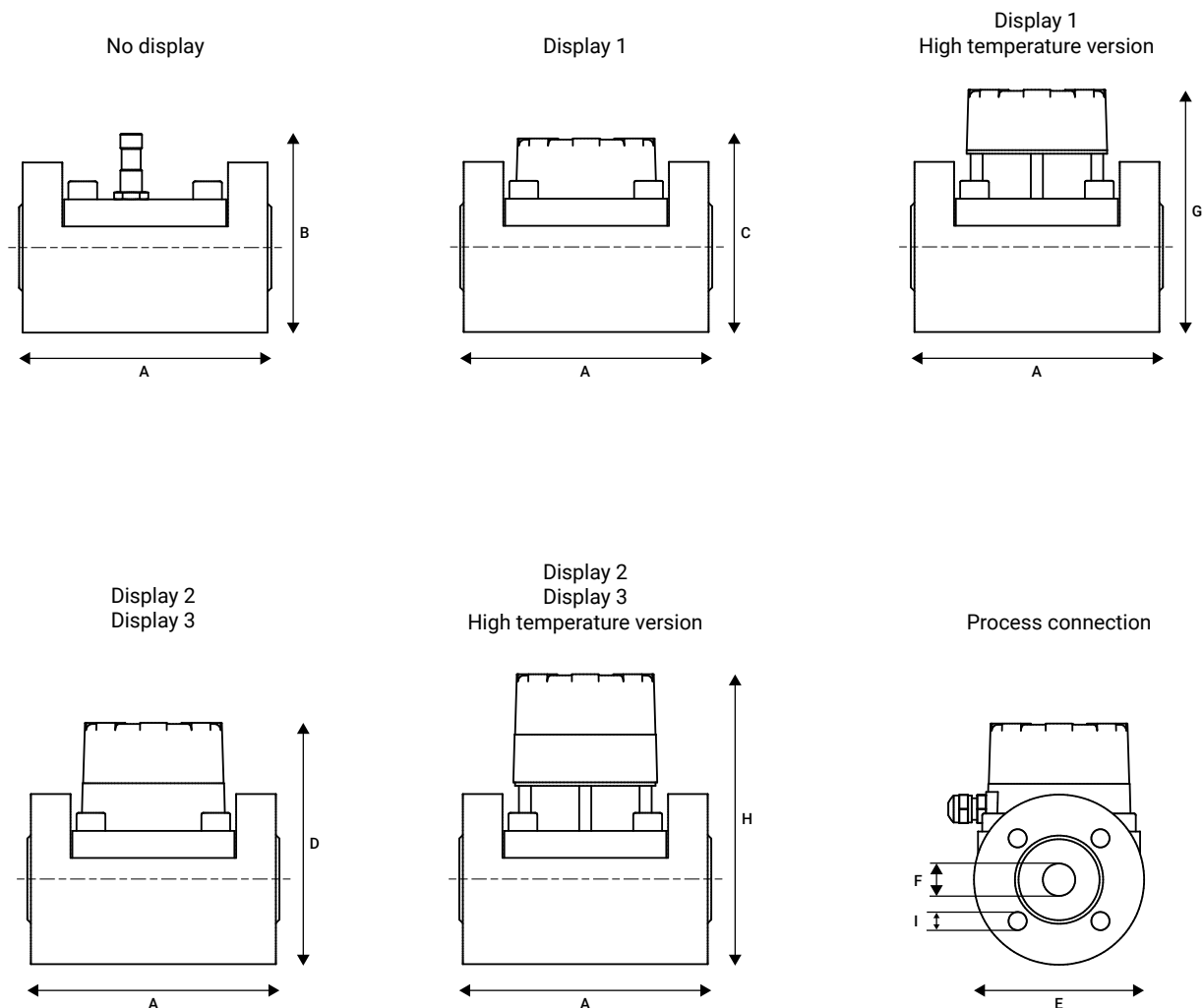

Dimensions [mm]				
Size	VO 2	VO 10	VO 50	VO 115
A / Installation	140	170	184	196
C	108	153	165	243
B <sub>max</sub> *, D	135	180	192	270
G	135	180	192	270
H	162	207	219	297
E	95	130	220	260
F / Process connection	DN 15	DN 25	DN 50	DN 50
I / Thread flange hole	4 x M12	4 x M12	4 x M16	4 x M16

\* Depends on sensor

# Article numbers

Order code								
Type								
Oval gear meters, series VO		VO						
Size	Process connection							
015	G ¼ female	01				I1K		
06	G ½ female	06				I3K		
1	G ½ female	1A				I3K		
2	G ¾ female	2A				I4K		
5	G 1 female	5A				I5K		
10	G 1 female	10				I5K		
50	G 2 female	50*				I8K		
115	G 2 female	11*				I8K		
2	DN 15 flange	2A				F3K		
10	DN 25 flange	10				F5K		
50	DN 50 flange	50*				F8K		
115	DN 50 flange	11*				F8K		
Materials								
Body	Oval gears							
Stainless steel	Stainless steel		VA					
Stainless steel	PEEK		VP					
Aluminium	PEEK		AP					
O-rings								
FKM (standard)				V				
EPDM				E				
FEP				P				
Sensor pulse output without display								
NPN						N		
PNP						P		
PNP (high temperature)*						H		
Sensor with display								
Display 1								
Battery powered, local display						D		
Display 2								
Battery powered, display and pulse output open collector						C		
Battery powered, remote display with 2 m cable length and pulse output open collector						B		
Battery powered, high temperature version, remote display and pulse output open collector						F*		
Display 3								
Display, pulse output open collector and analog output (4...20mA)						T		
Remote display with 2 m cable length, pulse output open collector and analog output (4...20mA)						A		
High temperature version, remote display, pulse output open collector and analog output (4...20mA)						G*		
Example order number			VO	01	VA	V	N	I1K

\* For stainless steel / stainless steel only, specified

Order code	
Service	
Calibration certificate for oval gear flow meters	VOWPS01