

Turbotron // VTH25, VTM25



Your advantages

Series	VTH25	VTM25
	<ul style="list-style-type: none"> • Cost optimized version 	<ul style="list-style-type: none"> • Pressure rating up to 50 bar

Type	VTH25		VTM25	
Material pipe section	Brass	Plastic PP	Brass	Stainless steel
Flow range	4...160 l/min*			
Accuracy	±5 % of of reading (up to 5 l/min 7 % of of reading)			
Repeatability	±0.5 %			
Signal output	< 1 l/min			
Medium temperature	0...85 °C**	0...80 °C** / 2 bar 0...60 °C** °C / 5 bar 0...30 °C** °C / 10 bar	0...85 °C**	
Pressure rating	PN 10		PN 50	
Nominal diameter	DN 25			
Process connection	G 1¼ male thread, supplementary screwed connection required, see accessories			
Sensor	Hall effect sensor		Hall effect sensor	
Output signal				
→ Pulse rate / K-factor	65 pulses/l		65 pulses/l	
→ Resolution	15 ml/pulse		15 ml/pulse	
→ Signal shape	Square wave signal NPN open collector		Square wave signal NPN open collector	
→ Signal current	Max. 19 mA		Max. 19 mA	
Electrical connection	2 m PVC cable, shielded (T _{max} = 75 °C)		4 pin plug connector M12 x 1	
Power supply	10...30 VDC optional 4.5...26.5 VDC		6.5...24 VDC short circuit proof and reverse polarity protected	
Degree of protection EN 60529	IP54			
Max. particle size in the medium	< 0.63 mm			

* not suitable for continuous operation

** non-freezing

Option

**Screen filter in the inlet
mesh size 0.4 mm**

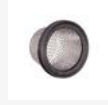

Typical pressure drop

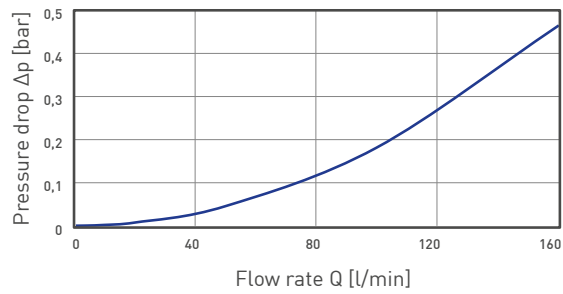

Characteristic curve

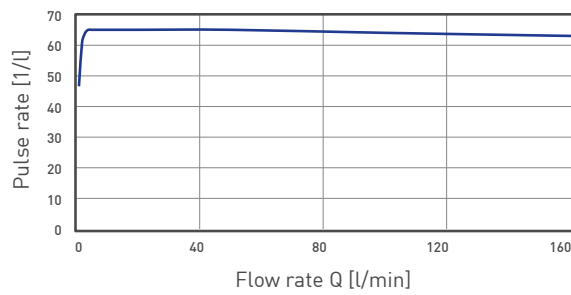

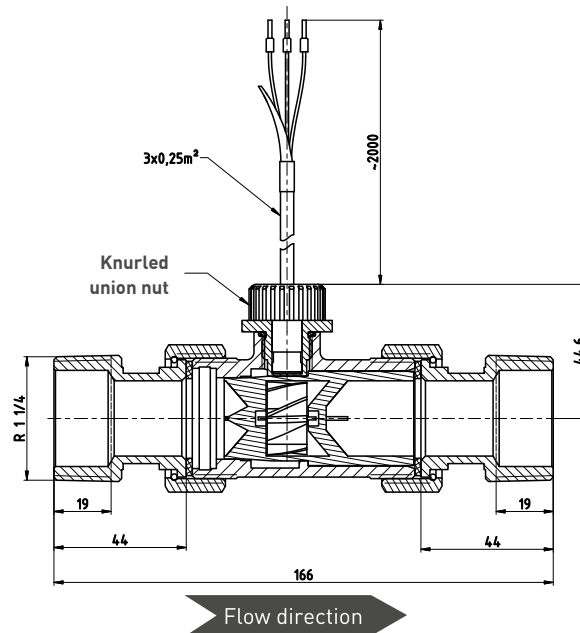

Materials in contact with fluid

	VTH25 brass	VTH25 plastic PP	VTM25 brass	VTM25 stainless steel
Pipe section	Brass CW724R	PP	Brass CW724R	Stainless steel 1.4571
Turbine cage	PS-ST Xarec® 20 % glass fibre reinforced			
Rotor	PS-ST Xarec® 20 % glass fibre reinforced			
Shaft	Stainless steel 1.4539			
Bearings	Sapphire / PA			
Housing for Hall effect sensor	PS-ST Xarec® 20 % glass fibre reinforced		Brass CW602N / CW614N	Stainless steel 1.4571
O-ring	EPDM			
Screen filter (option)	Stainless steel 1.4301		Stainless steel 1.4301	
Associated O-ring	EPDM		EPDM	
Spacer		PP		









Plastic parts of VTH25 brass / stainless steel comply with KTW-guidance or. the Elastomer Guideline of the German Federal Environmental Agency

Order code			Example → VT2511	MS	HNP000	F*	E*
Type							
VTH25 / VTM25			VT2511				
Material of pipe section							
Brass				MS			
Plastic PP (only VTH)				K6			
Stainless steel (only VTM)				VA			
Version							
VTH25	Standard	10...30 VDC			HNP000		
	Option	4.5...26.5 VDC			HKP000		
VTM25					MNS000		
Options*							
Filter							
Screen filter (only brass or stainless steel version)						F	
None						0	
Electronics for VTM25							
Incl. transducer 4...20 mA							
→ Corresponds with 0...60 l/min							E
→ Corresponds with 0...100 l/min							F
→ Corresponds with 0...160 l/min							G
Switching output VE							6
Switching output VE with pulse output							7
Example order number			VT2511	MS	HNP000	F*	E*

* If you do not require any of the options, digits of the order code do not apply.



BEST
SELLER

Type	Order number
VTH25 Material of pipe section: Brass, Power supply: 10...30 VDC, without options	VT2511 MS HNP000

Order code				
Version	Connection adapters*			Order number
VT25, brass		Screw coupling G 1-ISO 228 with temperature sensor Pt100 / 3-wire	Material of gasket Centelen $T_{max} = 85 \text{ °C}$	VT1310
		Screw coupling R 1-DIN EN 10226-1 2004-10		VT25Z00000005
		Screw coupling R 1 1/4-DIN EN 10226-1 2004-10		VT25Z00000006
		Soldering coupling for copper pipes $\varnothing 28 \text{ mm}$, PN 16		VT1312
VT25, plastic		Welding coupling PP for pipes outer diameter 25 mm	$T_{max} = 20 \text{ °C}$, PN 10 $T_{max} = 60 \text{ °C}$, PN 2.5	VT1303
		Bonding coupling PVC for pipes outer diameter 25 mm		VT1304
		Hose barb PP $\varnothing 30 \text{ mm}$ $\varnothing 32 \text{ mm}$		VT1308 VT1309
VT25, stainless steel		Screw coupling R 1	Material of gasket Centelen $T_{max} = 85 \text{ °C}$	VT1333

* Supplied piecewise

** The use of connection adapters may result in deviations in accuracy.

Order code					
Series	Connection cables			Length	Order number
VT25		Connection cable for turbine flow sensor with cable socket M12 x 1 moulded lead, 4-pin, shielded, sheathing material PUR ($T_{max} = 70 \text{ °C}$) UL-approval	3 m 5 m 10 m	XVT2053	
				XVT2009 XVT2070	
		4-pin cable socket M12 x 1 angle type, unassembled		VT1331	

