

EX800-SERIES

INSERTION ELECTROMAGNETIC FLOW SENSOR



APPLICATIONS

Small pipe applications (1"-12")
Conductive fluids
Clean or 'dirty' liquids
Industrial processes
Chemical metering pumps
Fertigation

Features

- No moving parts
- Economical
- Durable
- Easy to install
- Easy to maintain
- NSF/ANSI standard (stainless only)
- Data logger (optional)
- Immersibility (optional)
- Reverse flow output (optional)
- Sensus smart output (optional with display)
- NSF/ANSI standard 61 & 372 (stainless only)

Contact Your Supplier

EX800-Series insertion electromagnetic flowmeters are designed for use with conductive liquids in 1 to 12" pipe. A choice of materials (stainless steel, brass, and PVC) allows the meter to adapt to a range of temperature, pressure, and corrosive environments.

The EX800 is highly suitable for difficult applications with changing viscosities. With no moving parts, these meters can be used in "dirty water" applications where debris would foul a mechanical meter. Like all magmeters, when used in chemical injection applications, these meters should be installed upstream of the chemical line (or far enough downstream to allow complete mixing of fluids before the meter).

Designed for modularity and versatility, the EX800-Series has a current-sinking pulse output that can be combined with the appropriate transmitter or indicator for the application. For basic rate/total and pulse output, the FT430 is best. For analog output and display of rate and total, the FT440 can be used. Electronic modules can be wall- or meter-mounted. If the EX800 meter is used with a programmable controller, the output signal can be fed direct, with no other conditioning required.

EX800-Series fixed depth insertion meters require special fittings. Factory installation in the fitting ensures correct depth placement in the pipe. The EX800-Series meter can be ordered in a full power model when a source of electricity is available, or in a low power model that can run on an external battery with solar panel.

EX800-SERIES
INSERTION ELECTROMAGNETIC
FLOW SENSOR



Features

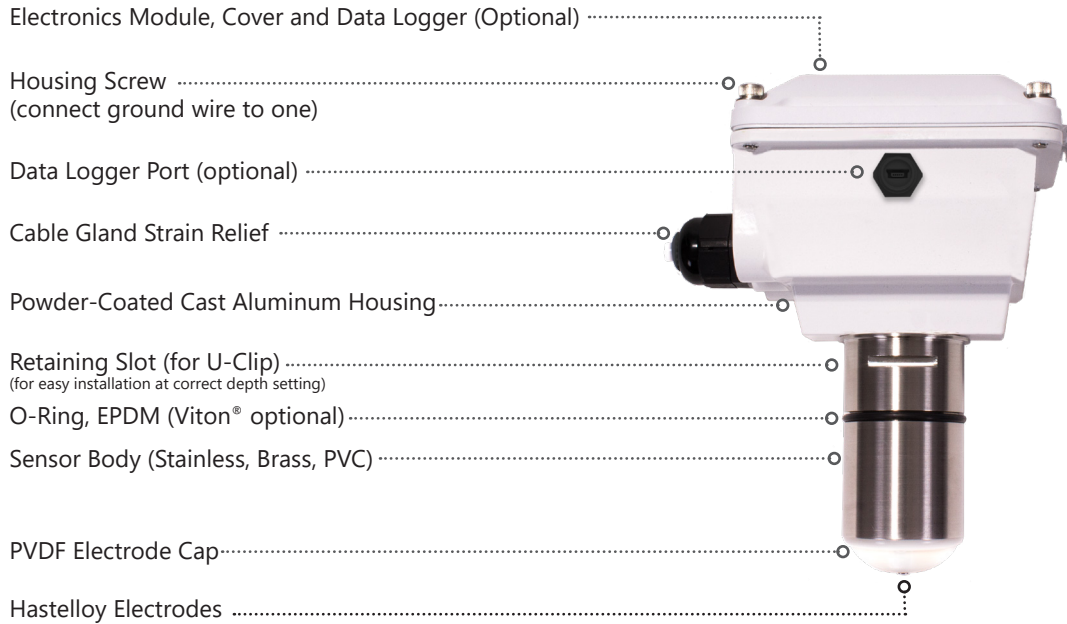

Specifications*

Pipe Size	1" to 12"	
Power	Full Power: 12 - 24 Vdc, 250mA	Low Power: 12 - 24 Vdc, 40mA average with 250mA peaks
Materials	Housing	Powder-coated cast aluminum
	Sensor Body	316 Stainless Steel, Brass, or PVC
	O-ring	EPDM (Viton® optional)
	Electrodes	Hastelloy
	Electrode Cap	PVDF (Kynar®)
Maximum Pressure	Brass/Stainless Steel	PVC (See Pressure vs. Temp. Chart)
	200 psi (14 bar)	150 psi (10 bar) @ 75° F (24° C)
Temperature	Ambient	0° to 160° F (-17° to 72° C)
	Fluid	32° to 200° F (0° to 93° C)
		32° to 130° F (0° to 55° C) @ 0 psi
Minimum Conductivity	20 microSiemens/cm	
Flow Velocity	0.28 to 20 ft/sec (0.08 - 6.09 m/sec)	
Accuracy	± 1% of full scale	
Output	Square wave pulse, opto-isolated, 500 Hz @ 20 ft/sec	
Empty Pipe Detection	Software, defaults to zero flow	
Cable	Standard 18' (6m), #22 shielded twisted pair, 4-conn. Max. cable run at 24 Vdc = 1000' (300m); at 12 Vdc = 500' (150m). For other circumstances, contact the factory.	
Environmental	See meter mounted electronic specification for rating.	
Regulatory	CE Mark (applies to full power sensor only configuration and full power FT 430/440 mounted configurations). Certified to NSF/ANSI standard 61 and NSF 372 (Stainless only with EPDM O-ring. Viton pending)	

*Specifications subject to change • Please consult our website for current data (www.seametrics.com).
 Kynar is a registered trademark of Arkema, Inc., Viton is a registered trademark of DuPont Corporation.

Flow Range

Nominal Pipe Size	1"	1½"	2"	3"	4"	6"	8"	10"	12"
Min GPM	.69	1.5	2.7	6.2	11	25	43	68	99
Min LPM	2.6	5.6	10.2	23.4	41	94	162	257	374
Max GPM	49	110	196	440	783	1760	3130	4900	7050
Max LPM	185	416	741	1665	2963	6662	11848	18548	26687

Dimensions

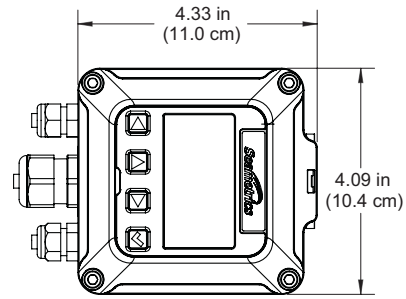
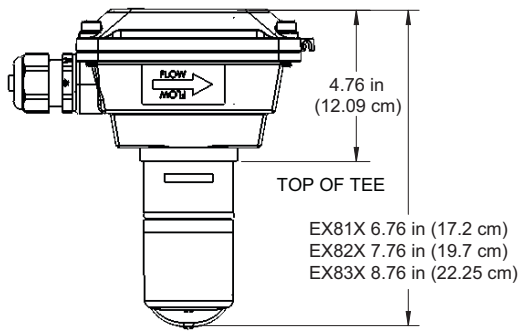

EX800-Compatible Fittings

	Tee	Saddle	Weldolet	Sweat Tee
Bronze	1" - 4"	3" - 4"	3" - 12"	1" - 4"
PVC	1" - 2"	3" - 8"	x	x
Stainless Steel	1" - 2"	x	3" - 12"	x
Carbon Steel	1" - 2"	x	3" - 12"	x
Ductile Iron	x	3" - 12"	x	x

Pressure vs. Temperature (PVC)

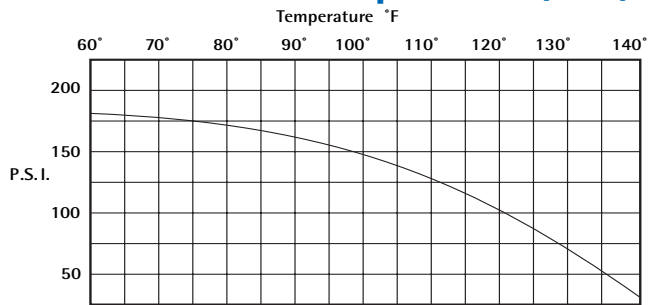

PVC Block Tee Fitting (Figure 1)

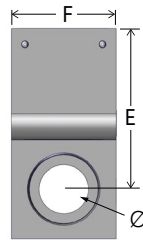
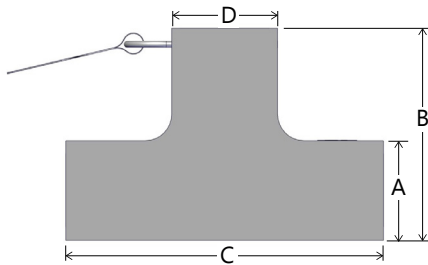

PVC Tee Fittings (Figure 2)

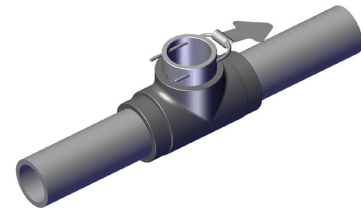
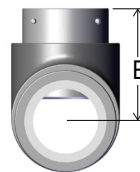
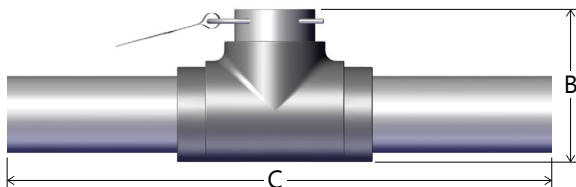

Figure	Pipe Size	A	B	C	D	E	F	Ø
1	1"	1.88" (4.77 cm)	4.00" (10.16 cm)	6.00" (15.24 cm)	2.00" (5.08 cm)	3.06" (7.77 cm)	2.00" (5.08 cm)	1.325" (3.36 cm)
2	1 1/2"	—	4.50" (11.43 cm)	19.4" (49.28 cm) <i>(nominal)</i>	—	3.35" (8.51 cm)	—	—
2	2"	—	4.90" (12.45 cm)	19.9" (50.55 cm) <i>(nominal)</i>	—	3.45" (8.76 cm)	—	—

How to Order

Sensor Only	Description	Size	Sensor Material	Options
	Externally powered (12 - 24Vdc) sensor only.	1" - 3" = EX810 4" - 10" = EX820 12" = EX830	Brass = B 316 Stainless Steel = S PVC = P	Reverse Flow Output = -15 *Immersible = -40 Low Power Option = -50 Viton® O-Ring = -125

FT430 Mounted on Sensor	Description	Size	Sensor Material	Options
	Externally powered sensor (12 - 24Vdc) with FT430 rate and total indicator (with pulse outputs) mounted on the sensor.	1" - 3" = EX813 4" - 10" = EX823 12" = EX833	Brass = B 316 Stainless Steel = S PVC = P	Reverse Flow Output = -15 Tamper Evident Kit = -32 Low Power Option = -50 Non-resettable Total = -64 Dual Relay Output = -98 Viton® O-Ring = -125 Hinged Display Cover = -126 Internal Data Logger = -127 Sensus Smart Output (Includes 6' Cable) = -150

FT440 Mounted on Sensor ¹	Description	Size	Sensor Material	Options
	Externally powered sensor (12 - 24Vdc) with FT440 rate and total indicator (with pulse and 4-20mA outputs) mounted on the sensor.	1" - 3" = EX819 4" - 10" = EX829 12" = EX839	Brass = B 316 Stainless Steel = S PVC = P	Reverse Flow Output = -15 Tamper Evident Kit = -32 Low Power Option = -50 Non-resettable Total = -64 Dual Relay Output = -98 Viton® O-Ring = -125 Hinged Display Cover = -126 Internal Data Logger = -127 Sensus Smart Output (Includes 6' Cable) = -150

* Immersible to maximum of 3 ft (1m), up to 2 weeks

¹ When ordering an EX with an FT440 mounted, the EX sensor cannot be loop powered.

User is responsible for reviewing end use application with their supplier for product suitability.